

# VIVANCE-02

## User Manual

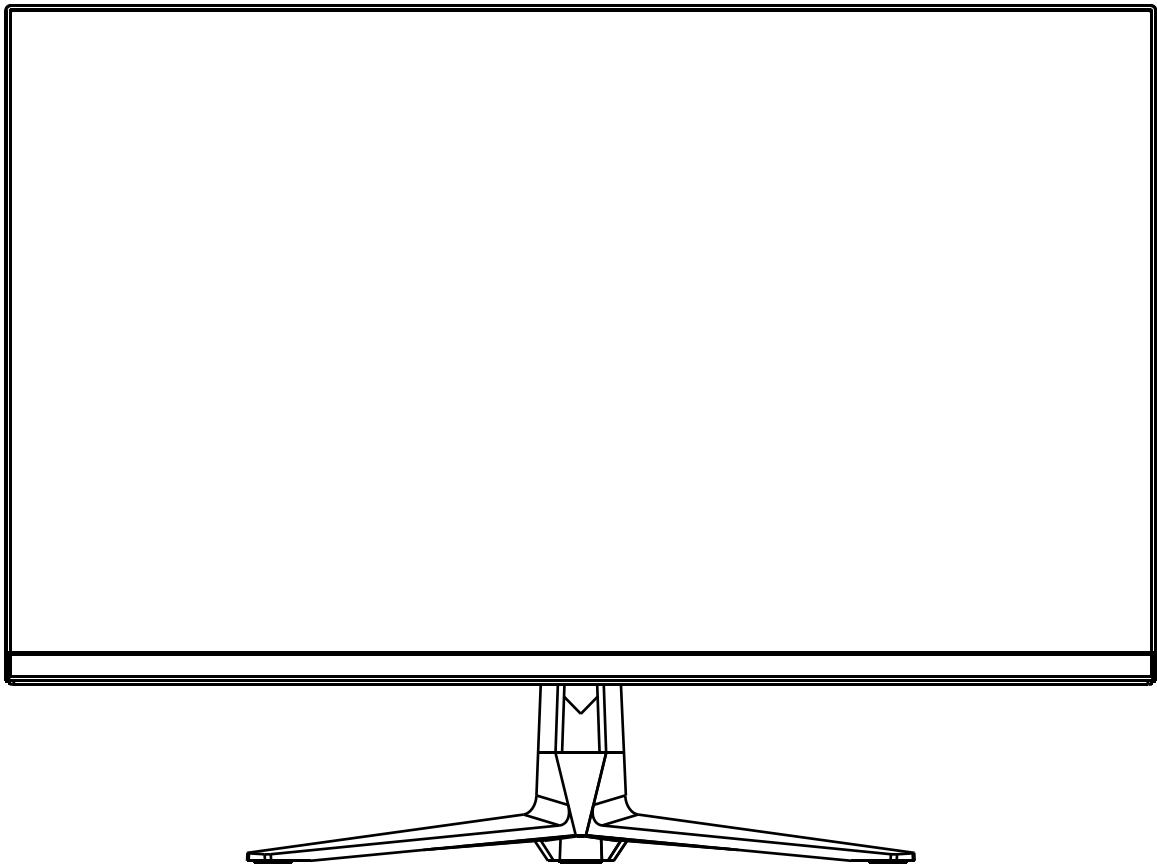

### **Instructions manual**

Please read this manual carefully, and keep it handy for future reference

## SAFETY INFORMATION



- Read these instructions - All the safety and operating instructions should be read before this product is operated.
- Keep these instructions - The safety and operating instructions should be retained for future reference.
- Heed all warnings - All warnings on the appliance and in the operating instructions should be adhered to.
- Follow all instructions - All operating and usage instructions should be followed.
- Do not use this equipment near water, or in humid environments – The appliance should not be used near water or moisture e.g. in a wet basement or near a swimming pool.
- Clean only with a dry cloth. Do not use solvents or petroleum based fluids.
- Do not block any ventilation openings.
- Do not install near any heat sources such as radiators, stoves or other apparatus (including amplifiers) that produce heat.
- Do not tamper with the supplied plug. This plug is a BS1363 standard plug.
- Protect the power cord from being walked on or trapped, particularly at the plug and at the point where it exits from the appliance.
- Only use attachments/accessories specified by the manufacturer.
- Use only with a cart, stand, tripod, bracket or table specified by the manufacturer or sold with the apparatus. When a cart or stand is used, use caution when moving it to avoid any injuries or damage from it tipping over.
- Unplug the apparatus during lightning storms or when unused for long periods of time.
- Refer all servicing to qualified personnel. Servicing is required when the apparatus has been damaged in any way, such as if the power supply cord or plug is damaged, liquid has been spilled or objects have fallen into the apparatus or it has been exposed to rain or moisture, it does not operate normally or has been dropped.
- Please keep the unit in a well-ventilated environment.
- The monitor should only be connected to a mains power supply as rated on the back of the equipment.
- To prevent overload, do not share the same power supply socket with too many other electronic components.
- Do not place any connecting wires where they may be stepped on or tripped over.
- Do not place heavy items on the cable as this may cause damage.
- When removing from a socket hold by the plug and not the wires.
- Disconnect the power immediately and seek professional help if the plug or cable is damaged, liquid has spilt onto the set, if accidentally exposed to water or moisture, if anything accidentally penetrates the ventilation slots or if the set does not work normally.
- Do not remove the safety covers. There are no user serviceable parts inside.

Trying to service the unit yourself is dangerous and may invalidate the product's warranty. Only qualified personnel should service this apparatus.

- Do not block ventilation slots on the back cover. The monitor can be placed in a cabinet but ensure at least 5cm (2") clearance all around. Do not tap or shake the screen, this may damage internal components.
- **WARNING:** To reduce the risk of fire or electric shock, do not expose this apparatus to rain or moisture. The apparatus shall not be exposed to dripping or splashing and objects filled with liquids, such as vases, shall not be placed on the apparatus.
- **WARNING:** The wall plug socket is used as a disconnection device and should remain readily accessible.
- **WARNING:** The batteries shall not be exposed to excessive heat such as direct sunlight or fire.

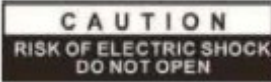

**AT FULL VOLUME, PROLONGED LISTENING MAY DAMAGE THE USER'S HEARING.**

 <p>This warning sign is to warn of dangerous voltage inside the product.</p>	 <p><b>CAUTION:</b> To reduce the risk of electric shock, DO NOT remove the cover (or back). No user serviceable parts inside. Refer servicing to qualified service personnel.</p>	 <p>This warning sign is to alert you of important instructions accompanying the product.</p>
---	--	---

## DISCLAIMER

Features and settings with their respective terms and images may be subject to change; thus there may be slight differences between the manual and the product.

## WHAT'S INCLUDED

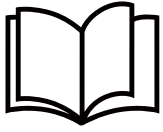

User manual

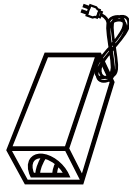

Power supply



Power cable



DP

## CONNECTIONS AVAILABLE ON THE MONITOR

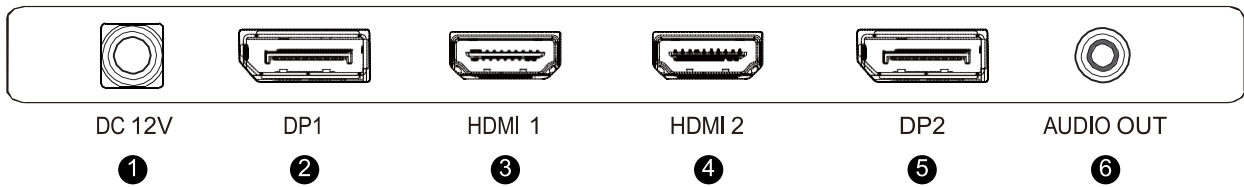

- 1 Power
- 2 DP1
- 3 HDMI 1
- 4 HDMI 2
- 5 DP2
- 6 AUDIO OUT



The terms HDMI, HDMI High Definition Multimedia Interface, and the HDMI Logo are trademarks or registered trademarks of HDMI Licensing Administrator, Inc.



## GETTING STARTED MONITOR CONTROLS

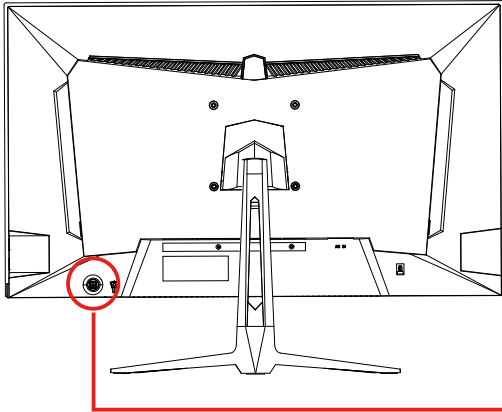

- Press 
- Power on
  - Entering submenus
  - Confirm selection/setting

### Flick actions

- UP - Scene Mode
- DOWN - Crosshair, press again to switch variants
- LEFT - Connector Signal, Exit
- RIGHT - Contrast and Brightness

### Press and flick

- UP - Scene Mode
- DOWN - Switch off monitor
- LEFT - Connector Signal
- RIGHT - Launching On-Screen Display (OSD)

## G-SYNC® EASY ON BUTTON

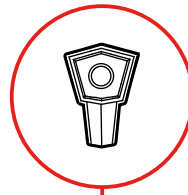
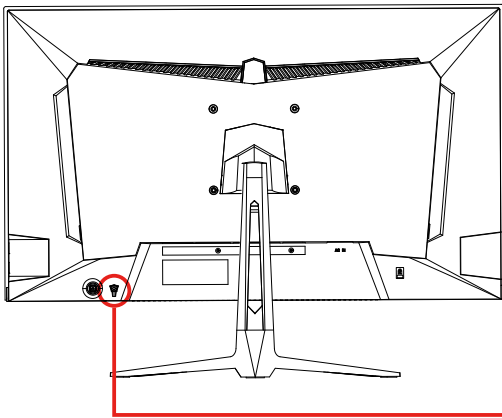

Press to turn  
G-SYNC® on/off.

## INITIAL SETUP

Connect the monitor to a power outlet.

1. Press the POWER button on the monitor or to turn it on (The indicator will be blue).
2. Connect the relevant cable to the corresponding input on the monitor. The source will be automatically detected.
3. To change between inputs, press the “Source” button to enter the source menu. Use the “◀” and “▶” buttons to choose the input source between DP1, DP2, HDMI1 and HDMI2.

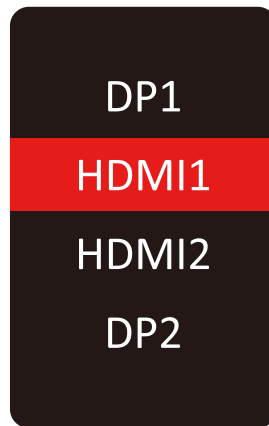

## MENU OPTIONS

The menu for the monitor can be accessed by pressing the menu button on the control panel. This menu is separated into the following sub menus: Profiles, Picture, Color, Audio, Input and Settings, details of each menu can be found in the following section.

## OSD MENU NAVIGATION

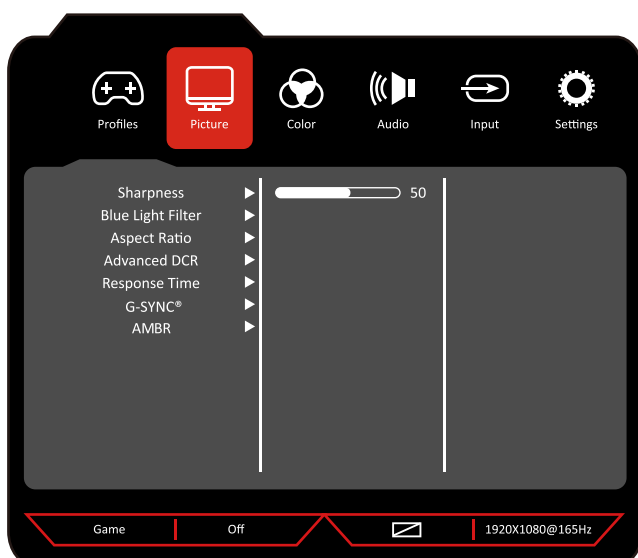

### NAVIGATION CONTROLS

- UP - next category
- DOWN - previous category
- LEFT - exit
- PRESS - select

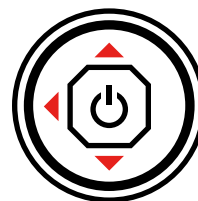

## OSD MENU

### A . Profiles

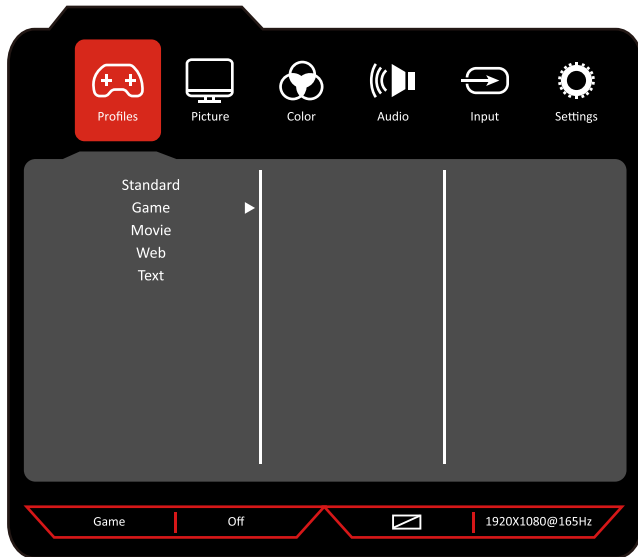

#### **Standard**

Enter standard mode.

#### **Game**

The game mode is divided into FPS1, FPS2, RTS, Night Vision, Gamer1, Gamer2, Gamer3.

#### **Movie**

Enter movie mode.

#### **Web**

Enter web mode.

#### **Text**

Enter text mode.

### B . Picture

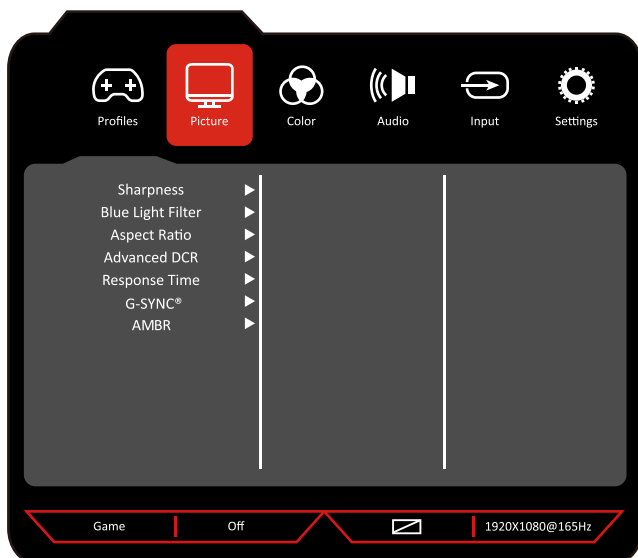

#### **Sharpness**

Change the clarity from 0 to 100.

#### **Blue Light Filter**

Change the display blue light from 0 to 100.

#### **Aspect Ratio**

Change the image aspect ratio to Wide Screen, 4:3, 5:4, 16:9, 16:10.

#### **Advanced DCR**

Change the Advanced DCR from 0 to 100.

#### **Response Time**

Turn the Response Time feature Off, High, Middle, Low.

#### **G-SYNC®**

Turn the G-SYNC® feature On or Off.

#### **AMBR**

Turn the Advanced Motion Blur Reduction feature On or Off.

## C. Color

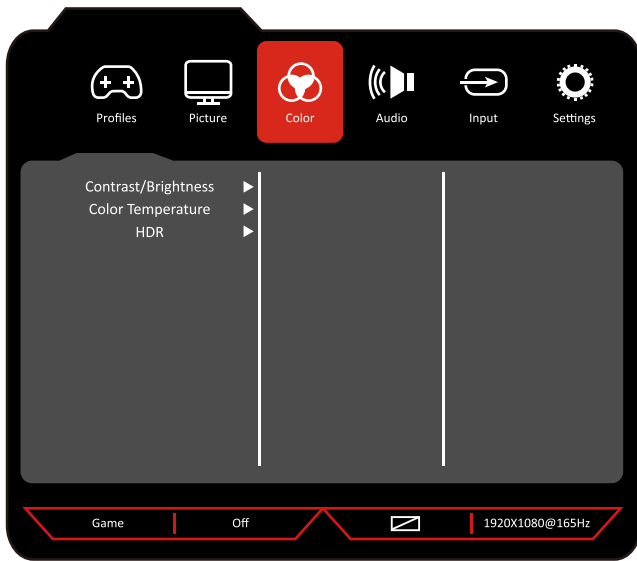

### **Contrast/Brightness**

Adjust the display brightness value contrast value from 0 to 100.

### **Color Temperature**

Turn the Color Temperature cool, standard, warm, user color.

### **HDR**

Turn the HDR off, auto, on.

## D. Audio

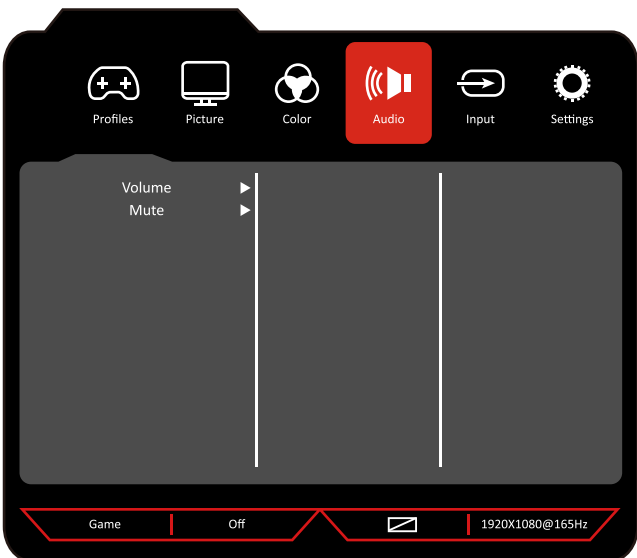

### **Volume**

Change the audio source volume from 0 to 100.

### **Mute**

Turn On or Off to mute the audio source.

## E . Input

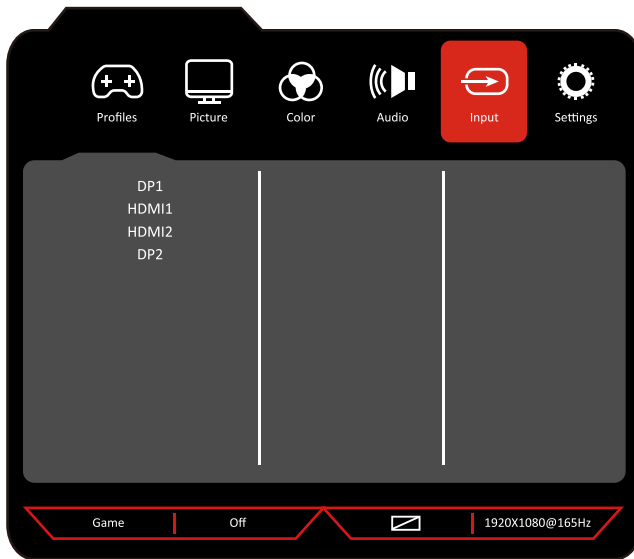

Switch the signal input to DP1, HDMI1, HDMI2, DP2.

## F . Settings

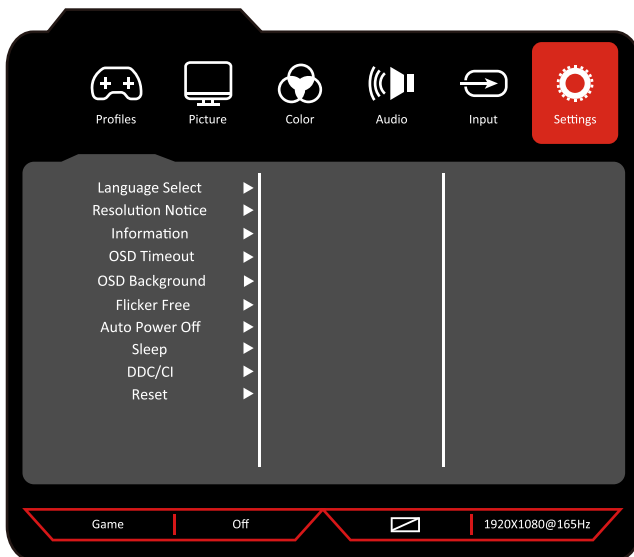

### Language Select

Change the OSD Menu display language.

### Resolution Notice

Turn the Resolution Notice feature On or Off.

### Information

Resolution: 1920x1080 Horizontal frequency: 160.0Khz Vertical frequency: 144.2 Clock frequency: 332.8MHz.

### OSD Timeout

Change the OSD Timeout from 0 to 100.

### OSD Background

Turn the OSD Background feature On or Off.

### Flicker Free

Turn the Flicker Free feature On or Off.

### Auto Power Off

Turn the Auto Power Off feature On or Off.

### Sleep

Change the sleep time to 30, 45, 60, 120min, Off.

### DDC/CI

Turn the DDC/CI feature On or Off.

### Reset

Restore factory default setting.

## SPECIFICATION

<b>Model</b>	VI-02
<b>Screen Size</b>	24"
<b>Aspect Ratio</b>	16:9
<b>Backlight</b>	LED
<b>Brightness</b>	350cd/m <sup>2</sup>
<b>Panel Type</b>	IPS
<b>Resolution</b>	1920x1080
<b>Refresh Rate</b>	165Hz
<b>Response Time</b>	MPRT 1ms
<b>Viewing Angle</b>	178°/178° (CR>10)
<b>Contrast Ratio</b>	1000:1
<b>VESA Mounting</b>	100x100mm
<b>Colors</b>	16.7M
<b>G-Sync</b>	Yes
<b>HDR</b>	Yes
<b>Signal Input</b>	HDMIx2+DPx2
<b>Audio</b>	
<b>Speakers</b>	2x3W
<b>Cables</b>	
<b>Power Cable</b>	Yes
<b>DP Cable</b>	Yes
<b>Additional Functions</b>	
<b>Low Blue Light</b>	Yes
<b>Flicker Free</b>	Yes
<b>Power Consumption</b>	36W
<b>Power Type</b>	DC 12V,3A